

**35% SUBMITTAL**

NOTE: SEE NOTE ON SHEET 3.



1305 FRANKLIN STREET, SUITE 410  
OAKLAND, CA 94612  
(510) 763-4895

- Civil Engineering
- Transportation Planning
- Highway & Rail Design

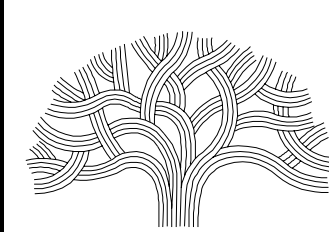

**CITY OF OAKLAND**

PROJECT NO. \_\_\_\_\_

CIVIL ENGINEER	No.	DATE	BY	REFERENCE
RCE NO. _____ EXP. _____				
CHECKED BY HO				
DESIGNED BY JHC				
DRAWN BY JHC				

**DEMOLITION**

23RD AVE IMPROVEMENT PROJECT

SCALE:  
HOR: 1" = 20'  
VERT: 1" = 20'  
DATE: 06/09/2006

SHEET NO.  
7 OF \_\_\_\_\_

DRAWING NAME: \$GETVAR, "DWGPREFX"\$(GETVAR, "DWGNAME")PLOT DATE: \$(EDTIME, 0), MO="DD"-YY PLOTTED BY: \$(GETVAR, "LOGNAME")

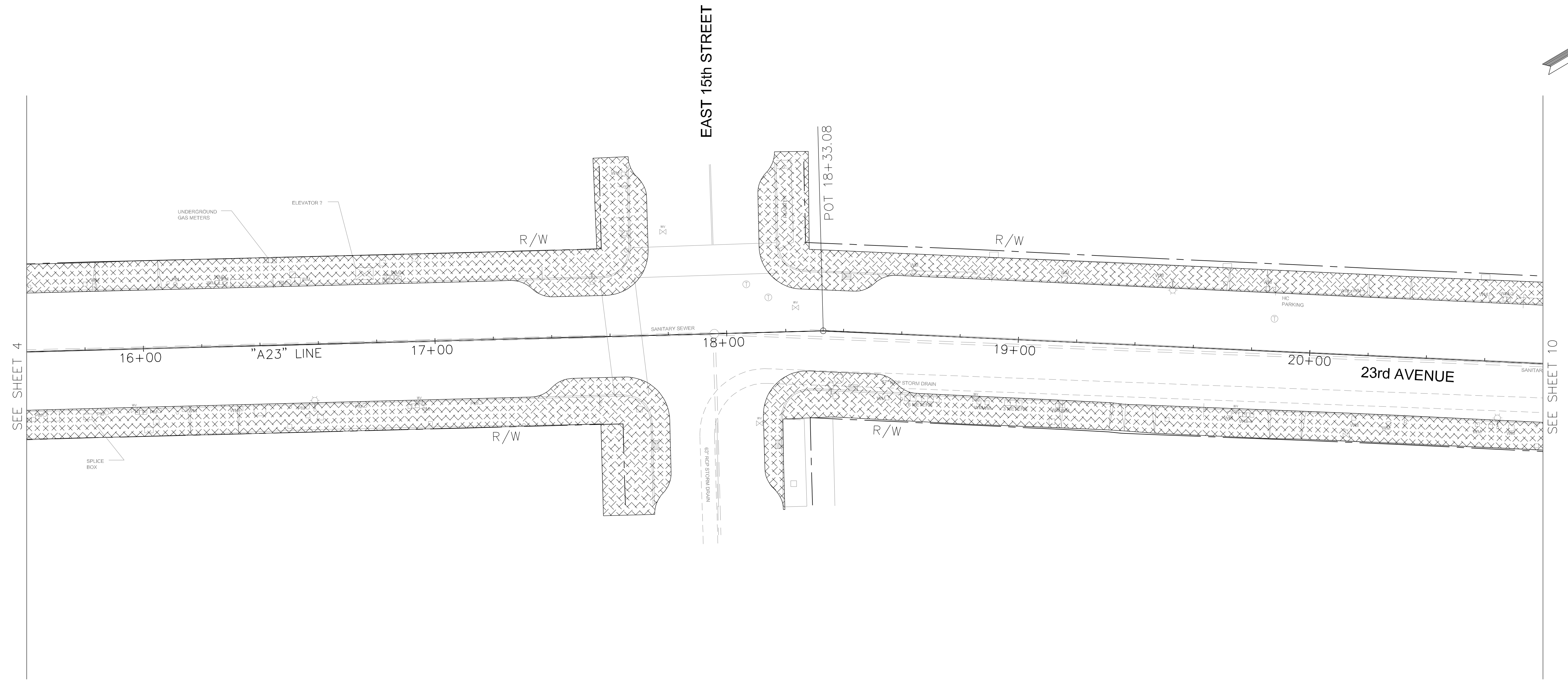
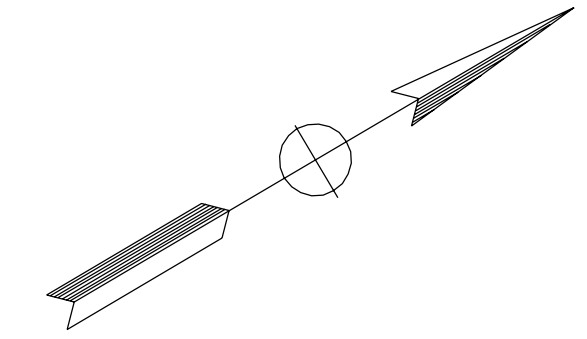

**35% SUBMITTAL**

NOTE: SEE NOTE ON SHEET 3.



1305 FRANKLIN STREET, SUITE 410  
OAKLAND, CA 94612  
(510) 763-4895

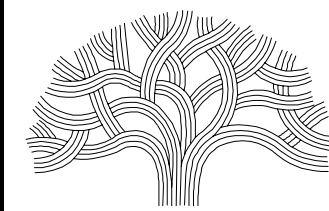

**CITY OF OAKLAND**

PROJECT NO. \_\_\_\_\_

CIVIL ENGINEER		No.	DATE	BY	REFERENCE
RCE NO.	EXP.				
CHECKED BY	HO				
DESIGNED BY	JHC				
DRAWN BY	JHC				

**DEMOLITION**

23RD AVE IMPROVEMENT PROJECT

SCALE:  
HOR: 1" = 20'  
VERT: 1" = 20'  
DATE: 06/09/2006

SHEET NO.

8 OF

DRAWING NAME: \$(GETVAR,"DWGPREFX")\$(GETVAR,"DWGNAME")PLOT DATE: \$(EDTIME,01,MO)-\$(DD)-\$(YY)PLOTTED BY: \$(GETVAR,"LOGINAME")

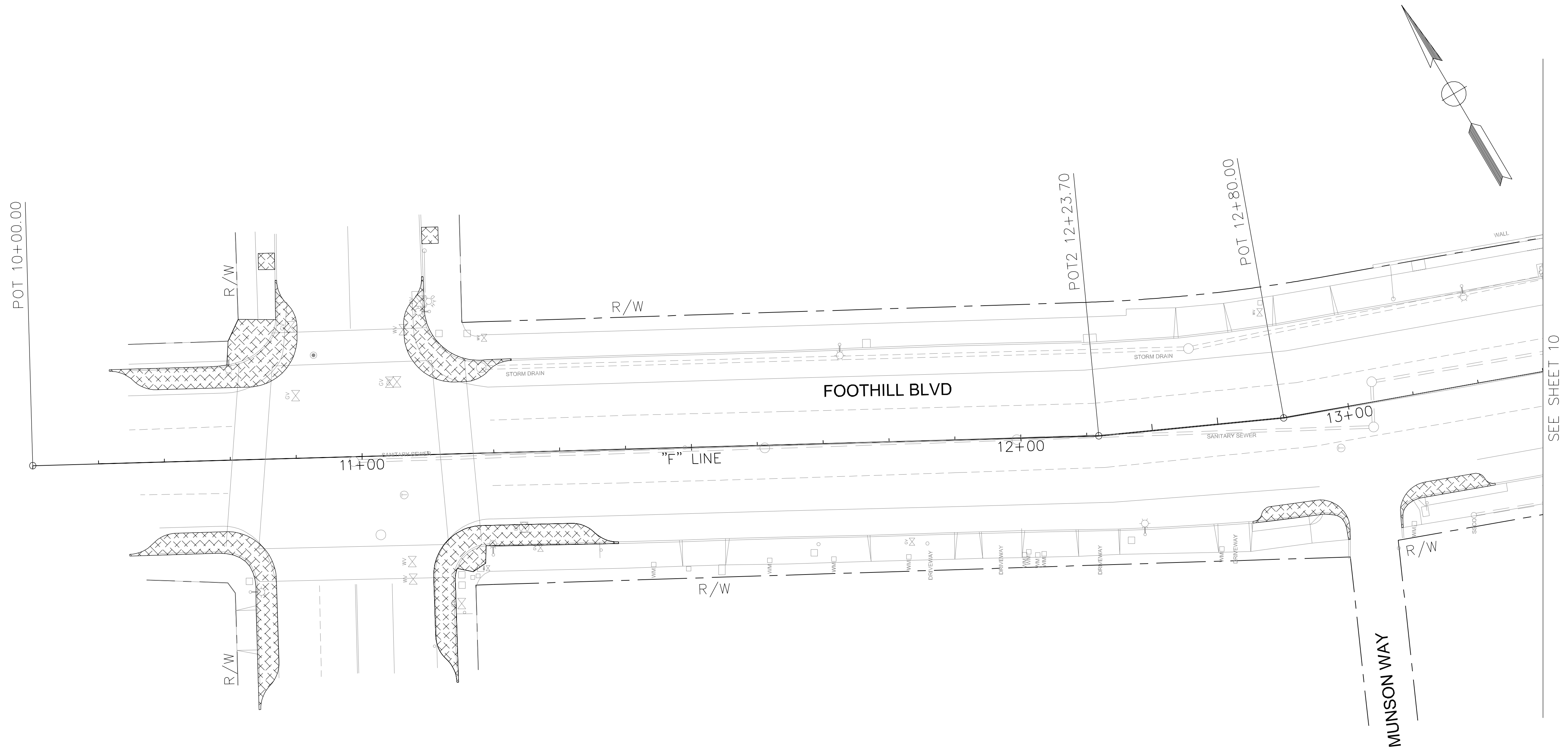

SEE SHEET 10

35% SUBMITTAL

NOTE: SEE NOTE ON SHEET 3.



1305 FRANKLIN STREET, SUITE 410  
OAKLAND, CA 94612  
(510) 763-4895

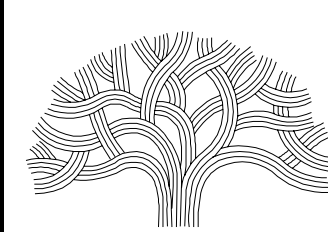

CITY OF OAKLAND

PROJECT NO. \_\_\_\_\_

CIVIL ENGINEER		No.	DATE	BY	REFERENCE
RCE NO.	EXP.				
CHECKED BY	HO				
DESIGNED BY	JHC				
DRAWN BY	JHC				

DEMOLITION

23RD AVE IMPROVEMENT PROJECT

SCALE:  
HOR: 1" = 20'  
VERT: 1" = 20'  
DATE: 06/09/2006

SHEET NO.  
9 OF

DRAWING NAME: \$GETVAR:DWGPREFIX;\$GETVAR:DWGNAME;PLOT DATE: \$EDTIME:0,MO-DO-YY;PLOTTED BY: \$GETVAR:LOGNAME;

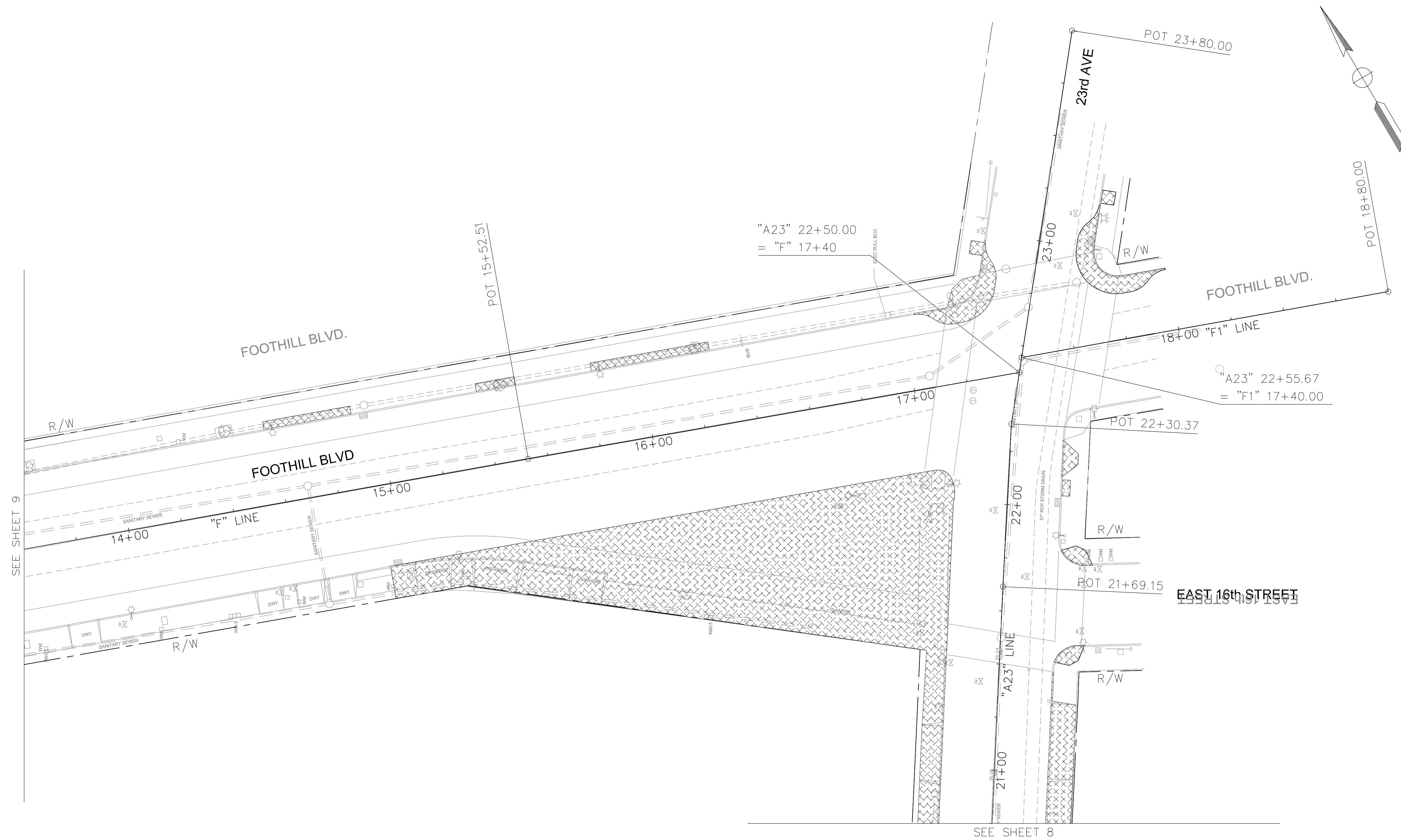

35% SUBMITTAL

NOTE: SEE NOTE ON SHEET 3.



1305 FRANKLIN STREET, SUITE 410  
OAKLAND, CA 94612  
(510) 763-4895

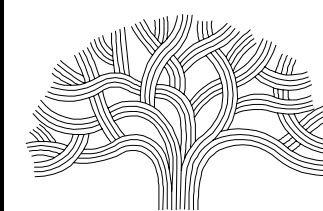

CITY OF OAKLAND

PROJECT NO. \_\_\_\_\_

CIVIL ENGINEER

RCE NO. \_\_\_\_\_ EXP. \_\_\_\_\_

CHECKED BY HO

DESIGNED BY JHC

DRAWN BY JHC

No.	DATE	BY	REFERENCE

DEMOLITION

23RD AVE IMPROVEMENT PROJECT

SCALE:  
HOR: 1" = 20'  
VERT: 1" = 20'  
DATE: 06/09/2006

SHEET NO.

10 OF \_\_\_\_\_

DRAWING NAME: \$(GETVAR,"DWGPREFIX")\$(GETVAR,"DWGNAME").PLOT DATE: \$(EDTIME,0,MO)-\$(EDTIME,0,DD)-\$(EDTIME,0,YY) PLOTTED BY: \$(GETVAR,"LOGNAME")